

CODE NUMBER

3365797BT

DESCRIPTION

Bluetooth, Trim Plate: None, Box Transformer Power Supply, Back-Check Tee, Polished Chrome Finish, 0.5 gpm, Multi-Laminar Spray, Infrared Sensor, Optima® Hardwired-Powered Deck-Mounted Low Body.

DETAILS

- Flow Rate: 0.5 gpm (1.9 Lpm) (0.5GPM)
- Spray Type: Multi-Laminar (MLM)
- Sensor Type: Infrared
- Mounting Type: Single Hole
- Mounting Size: Single Hole 1-1/4" to 1-1/2"
- Trim Plate: None
- Power Supply: Box Transformer (BOX)
- Temperature Mixer: Back-Check Tee (TEE)
- Finish: Polished Chrome (CP)
- Factory Default Timeout: 30 seconds
- Factory Default Gallons per Cycle: 0.25

FEATURES

ADA Compliant, Water Usage and Battery Strength Reporting, Wireless Settings Adjustment, Commercial Grade Faucet, Integrated Water Shut-off, Hygienic Line Flush, On-demand or Metered Activation, Self-adapting Sensor, Cast Brass Spout, Quick Connect Fittings

ELECTRICAL SPECIFICATIONS

- Sensor Range: 4" - 5" (102 - 127mm)
- Timeout Adjustment Settings: 30s

POWER SUPPLY OPTIONS

- 24VAC Box Transformer (included with BOX models), 0345370PK

VIDEOS

- ▶ Sloan Optima Below Deck Faucet
- ▶ PVD Special Finishes
- ▶ Sloan Connect App®

DOWNLOADS

- [Optima Smart Faucet Below Deck Installation Instructions](#)
- [Faucet Spray Heads Repair and Maintenance Guide](#)
- [Optima EBF-415 / ETF-410 Repair & Maintenance Guide and Parts Breakdown](#)
- [Additional Downloads](#)

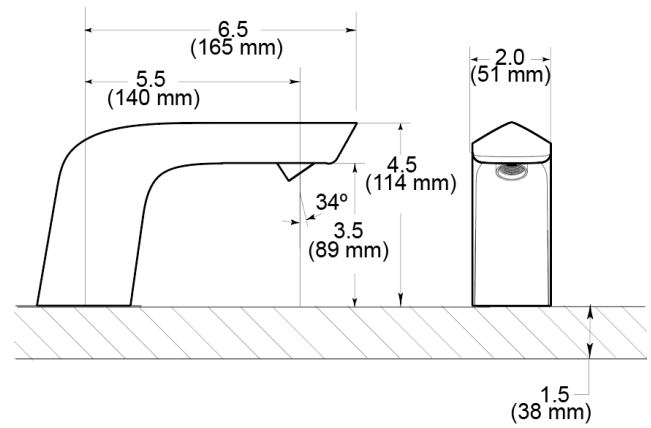

COMPLIANCES & CERTIFICATIONS



(ADA Compliant, ASME A112.18.1 Compliant, BAA Compliant, CalGreen Compliant, CEC Compliant, cUPC Certified, UPC Certified, UPC Low Lead Compliant, cUPC Low Lead Compliant, EPD, GPC 0.25 or less, HPD, IAPMO, WaterSense Listed, NSF-61, NYC604.4, Proposition 65, TAS, WELL Building Standard)

RECOMMENDED SPECIFICATION

Faucet shall include cast brass body, quick-connect fittings, twist-off/shut-off solenoid assembly, removable battery cartridge, flexible power supply and allow adjustment of settings wirelessly via Apple or Android smartphones.

NOTES

All information contained within this document subject to change without notice.

Sloan 10500 Seymour Ave, Franklin Park, IL 60131

Phone: 800.982.5839 • Fax: 800.447.8329 • sloan.com

Looking for other variations of the ETF-410 product? [View the general spec sheet with all options.](#)

[Find a matching soap dispenser for this faucet.](#)

[Find a compatible sink for this faucet.](#)

WARRANTY

[View Warranty Information](#)

ROUGH-IN

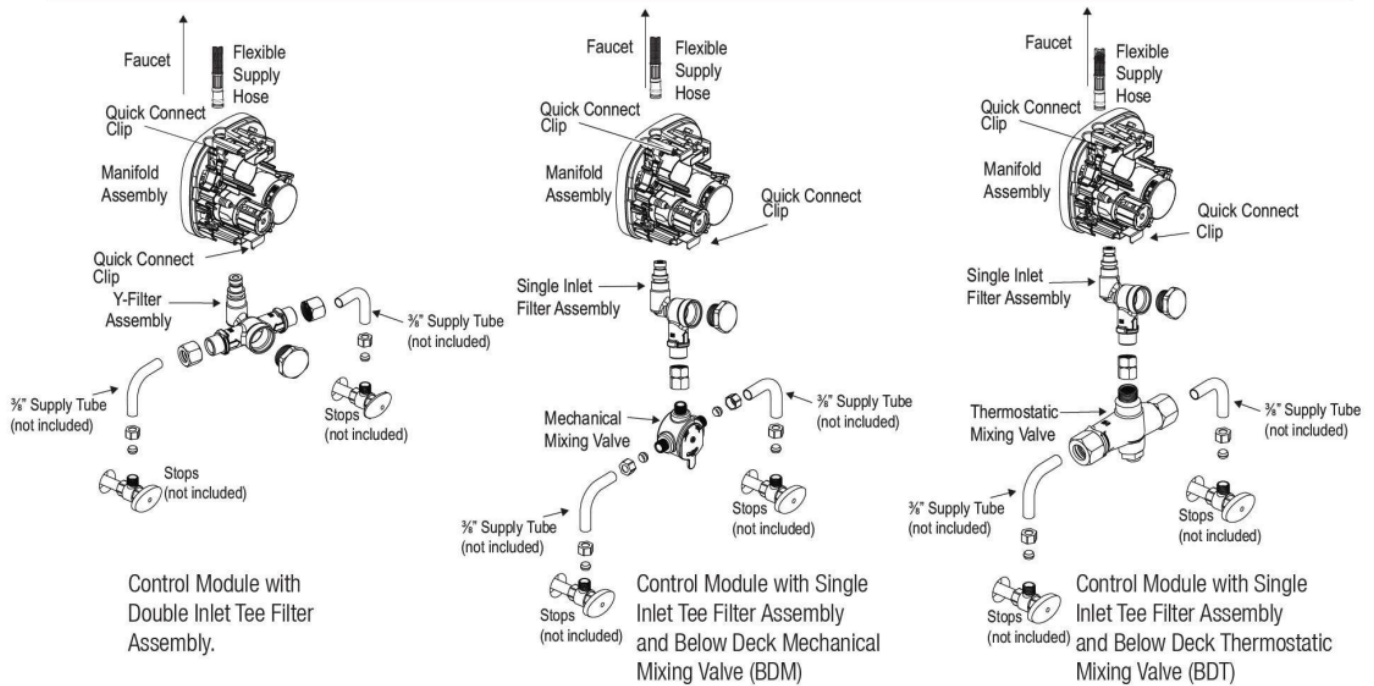

Sloan 10500 Seymour Ave, Franklin Park, IL 60131

Phone: 800.982.5839 • Fax: 800.447.8329 • sloan.com